



X-ray and magnetic-field-driven HED experiments on the Z facility

(or “how to do experiments on the Z facility by really trying.....”)

Michael E. Cuneo
Sandia National Laboratories

Sandia is a multiprogram laboratory operated by Sandia Corporation, a Lockheed Martin Company, for the United States Department of Energy's National Nuclear Security Administration under contract DE-AC04-94AL85000.



Outline

- Pulsed power is versatile: there are many ways to create unique and large scale size high energy density conditions using the extremely large pulsed currents and magnetic energy available
- The Z facility has a wide range of different sources, diagnostics, and other capabilities. The “Z facility” = Z pulsed power driver + Z-Beamlet + Z-PW + other capabilities.
- Innovations and terrific science have come and are sure to continue to come from the intersection of these capabilities in new and creative ways
- The key for a successful experiment is to build relationships with the facility personnel and technical experts, and a great deal of preparation and planning for 1-2 years in advance

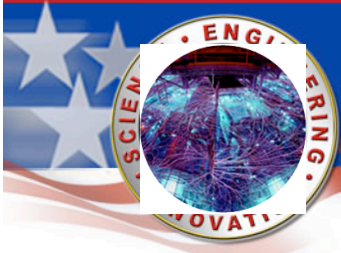

There are many ways to generate high energy density conditions on Z

- Many different types of radiation sources are produced by magnetically-driven cylindrical implosions
- These sources generate up to 100 – 2000 kJ of soft x-rays, harder x-rays (> 1 keV) or even 10-100 kJ of K-shell photons)
- Such x-ray sources are
 - cylindrical wire arrays
 - conical wire arrays
 - cylindrical foils or liners
 - gas puffs (in development)
 - planar wire arrays
 - radial wire arrays
 - x-pinchs
- We have some control over the x-ray radiation pulse shape

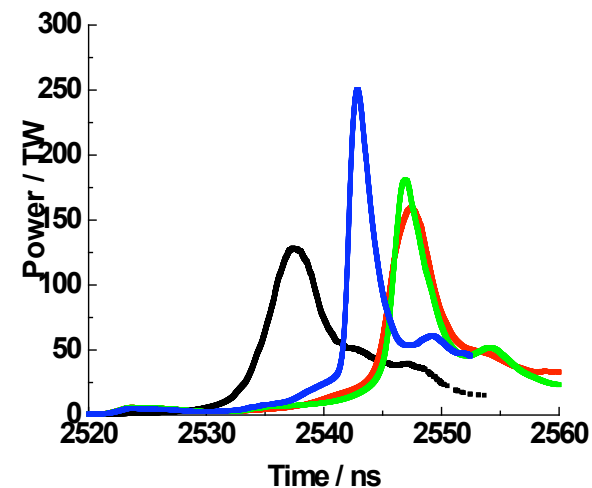



There are many ways to generate high energy density conditions on Z

- There are many demonstrated applications of these x-ray sources
 - Direct view of x-ray source
 - A x-ray radiation source driven hohlraum
 - **Radiation produced jets**
 - Radiation transport
 - Radiation hydrodynamics and instability growth
 - Atomic physics (opacity and photo-ionization)
 - Warm dense matter and degenerate plasmas
 - **Indirect drive fusion capsule implosions**
 - Double z-pinch
 - Dynamic hohlraum
 - Magneto-hydrodynamic produced jets (e.g. Ampleford talk)

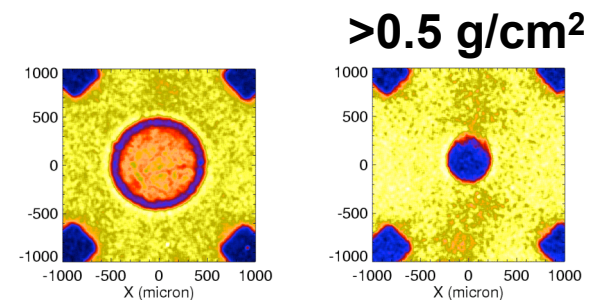
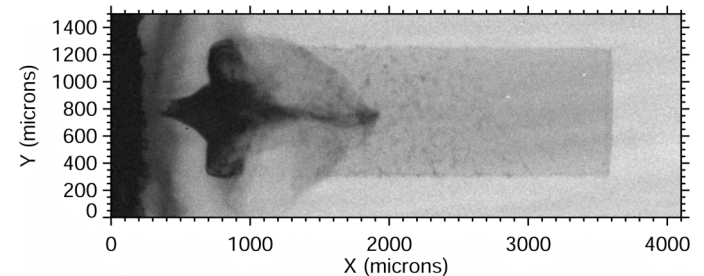

“Got rho-r?”

- There are a number of other applications that can be explored



There are many ways to generate high energy density conditions on Z

- The magnetic pressure is also used to create high pressure conditions in materials by a number of techniques (e.g. Lemke talk)
- These pressures are generated by planar and possibly cylindrical implosions
 - ICE (isentropic compression)
 - Flyer plates (shock Hugoniot)
- There are many applications to determination of material properties
 - EOS
 - Strength
 - Phase boundaries
- The science of dynamic materials could be advanced by new x-ray probing diagnostics (diffraction, Thomson scattering)

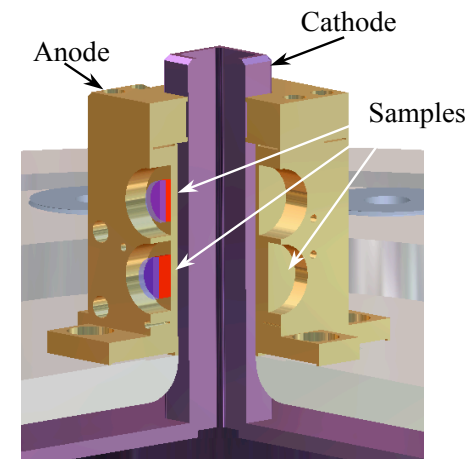



There are many ways to generate high energy density conditions on Z

- High magnetic fields are also being investigated to produce direct-drive fusion plasmas in cylindrical implosions of deuterium gas (magnetized target fusion – MagLIF, Slutz talk)
 - Magneto-hydrodynamic instability growth
 - Magnetic-field flux compression
 - Laser-plasma interactions with magnetized plasma
- High magnetic (50-1000 T) and electric fields (2 to 10 MV/cm) are also produced. These fields are crossed, e.g. perpendicular to each other.
 - Possible test bed for atomic physics and plasma spectroscopy in extreme conditions
 - Little thought has been given to this

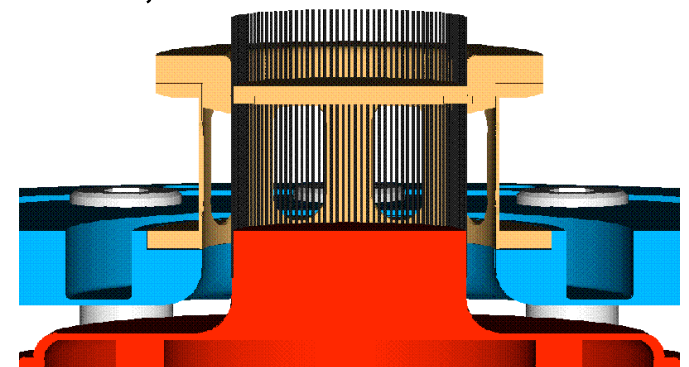
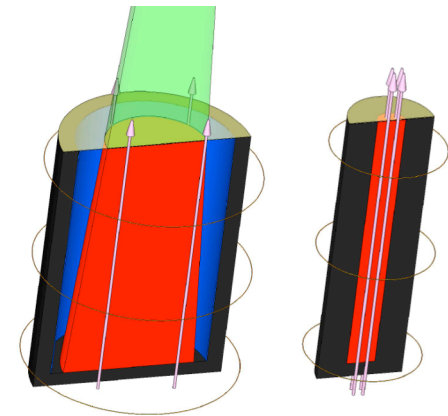

Magnetic pressure can generate interesting high energy density conditions



Radiation-Driven Spherical Implosion
(spherical rocket)

$$P = \frac{(2/5)(1-\alpha)\sigma T^4}{C_s} = 3T^{3.5} \text{ MBar}$$

140 MBar \approx 2e9 psi
at T = 300 eV

X-ray drive
temperature
T

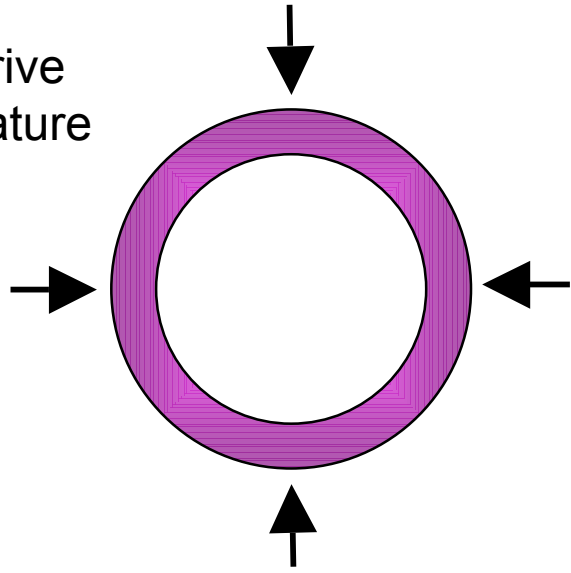

Magnetically-Driven Cylindrical Implosion

$$P = \frac{B^2}{2\mu_0} = 1.57e-3 \left(\frac{I_{MA}}{R_{cm}} \right)^2 \text{ MBar}$$

97 MBar \approx 1e9 psi
at I = 25MA, R = 0.1 cm

Drive
current
I

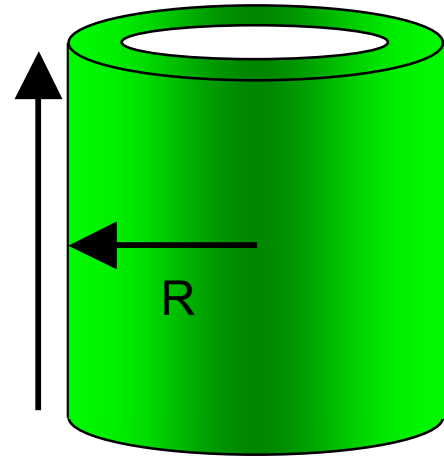

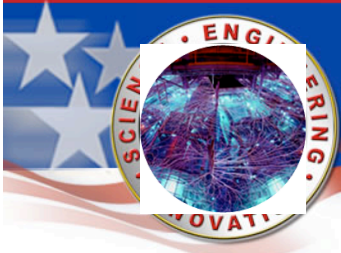

The facility has a number of mature diagnostics

- VISAR (Velocity Interferometer System for Any Reflector)
- Z-Beamlet for two-frame or two-color radiography with bent crystals
 - 1.865 keV or 6.151 keV
 - 1 ns temporal resolution, 10-20 μm spatial resolution
- Wide array of x-ray power and energy diagnostics
- Pinhole camera imaging (radial and axial)
- A wide array of time-integrated and time-resolved spectrometers (radial and axial)
- Neutron yield (activation) and neutron time-of-flight (radial and axial)
- Power flow electrical diagnostics (voltage and currents)

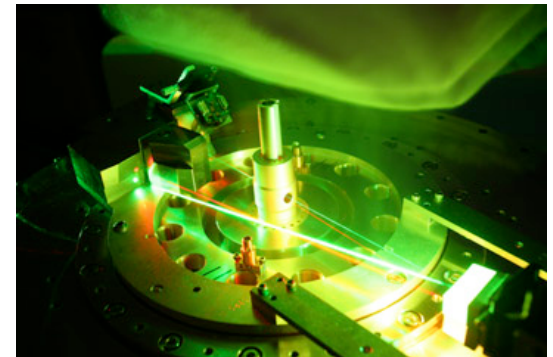



Two-frame, high resolution x-ray backlighting is an important diagnostic now in routine use on Z

Z-pinch implosion

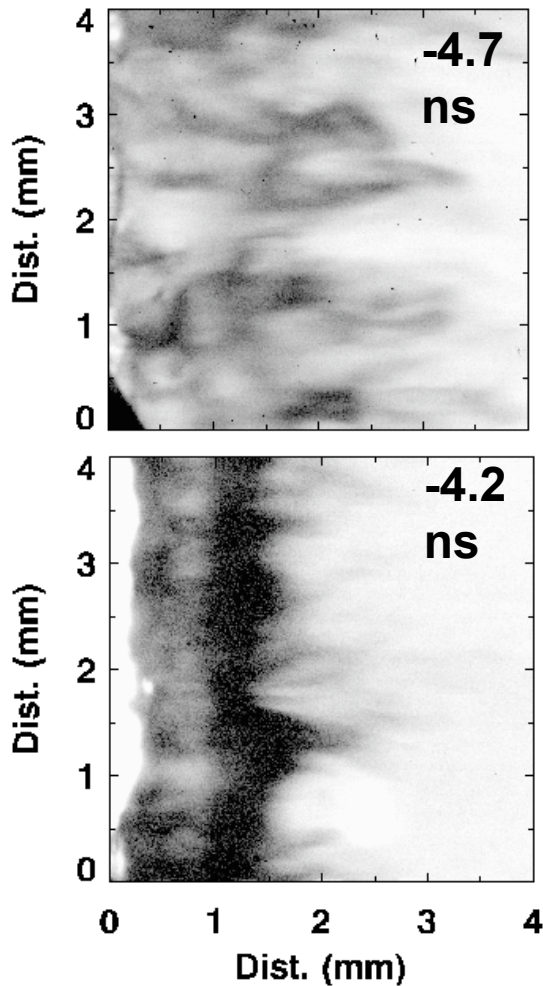

6.151 keV x-ray radiograph of imploding capsule ($C_r = 1.7$)

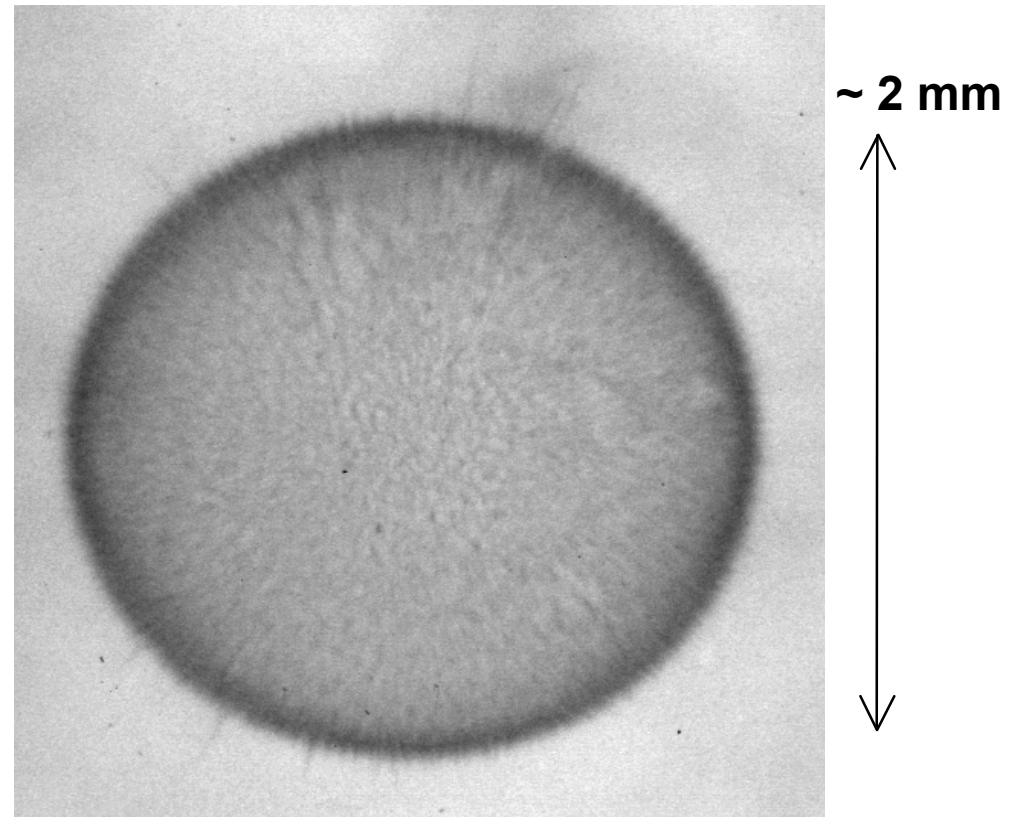

Backlighter developed by: D. B. Sinars, G. R. Bennett
Experiments by Cuneo et al



Other diagnostics

- Development in progress or planned
 - Gated detectors for multi-frame radiography
 - Neutron bang time
 - Neutron imaging
 - X-ray Thomson scattering

- Diagnostic that have been “discussed”
 - Visible streak imaging
 - Optical spectroscopy
 - X-ray streak imaging
 - Streaked x-ray spectrometer
 - many others.....



B. Y. O. D. (Bring your own diagnostic?)

- There are “user” ports to mount your diagnostic.
- It’s a challenging environment (debris, electrical noise, background)
- You will need lots help/advice from our diagnostic experts.
- It’s expensive.
- Will need to integrate diagnostic infrastructure with the facility
- There are always ESH issues that must be addressed
- Plan ahead. If it’s a modification of what has been done before, it may take 1 year.
- If it’s never been done before, it will probably take more than 1 year to get something to work.



The 2-3 MJ of magnetic energy and radiation destroys the experimental hardware following the pulse

“Hostile” environment

debris, electrical noise, photon background, plasma

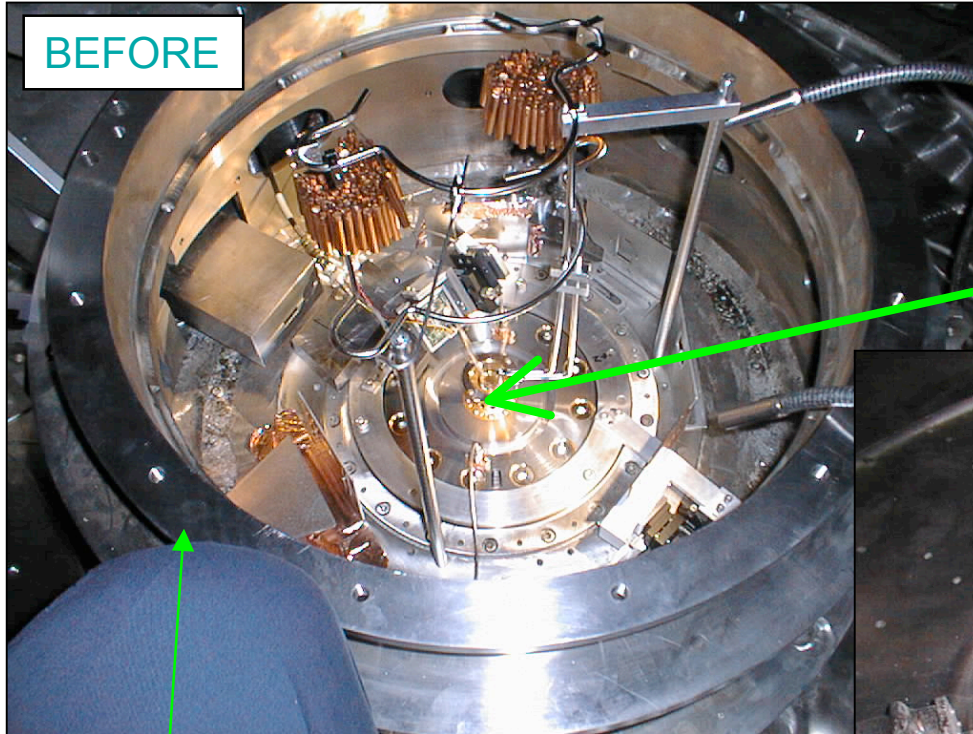

BEFORE

Wire array

Blast shield

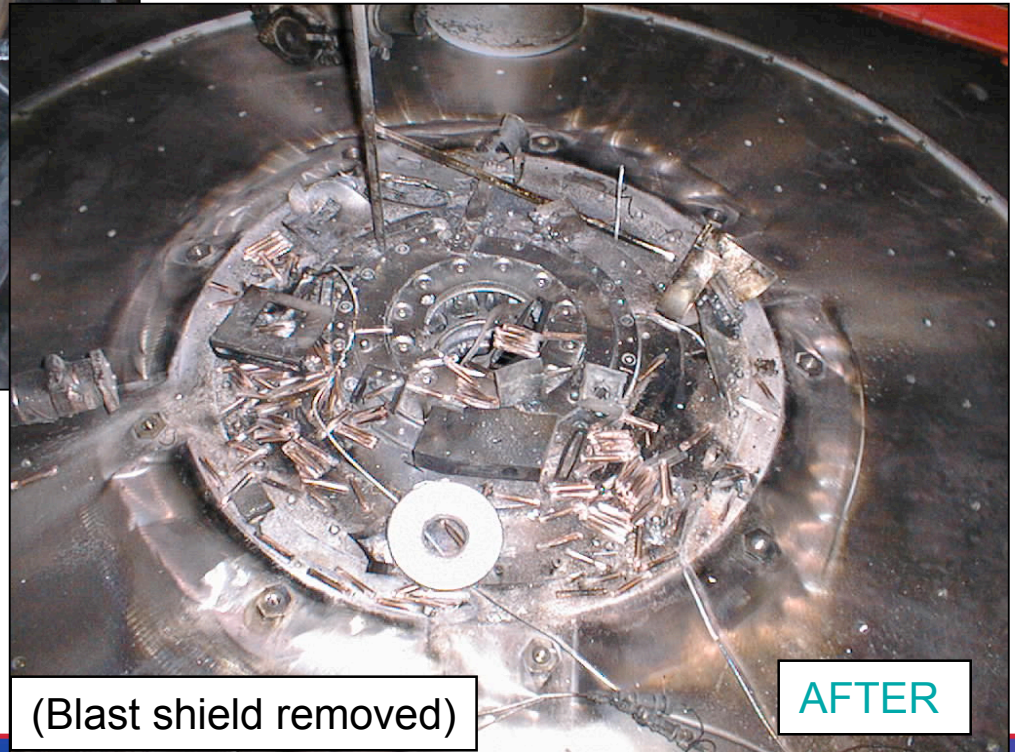

(Blast shield removed)

AFTER

Equivalent to 2 lbs high explosive released in a few ns in <1 cc volume!

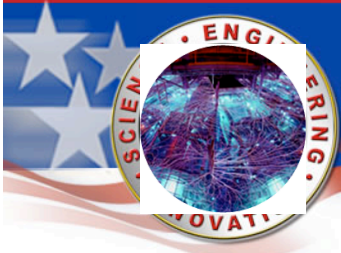

Additional capabilities are also available

- Gas filled targets and gas cells (low (5 mTorr) to high pressure (1000 psi))
- Cryogenic cooling capability to liquid or high pressure fluids (H₂, D₂, Xe)
- Planar target heating capabilities (inductive heating)
- Shaping of the drive current pulses (100 to 600 ns)
- Target fabrication of “simple” targets (what’s simple? – it depends)
- Extensive target characterization through our collaborations with General Atomics

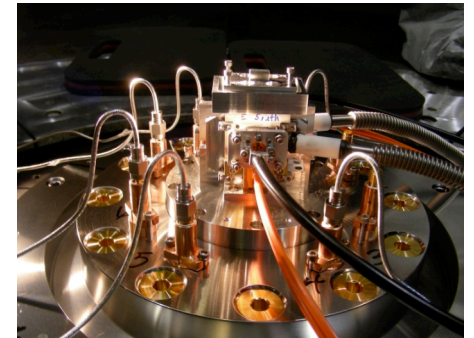
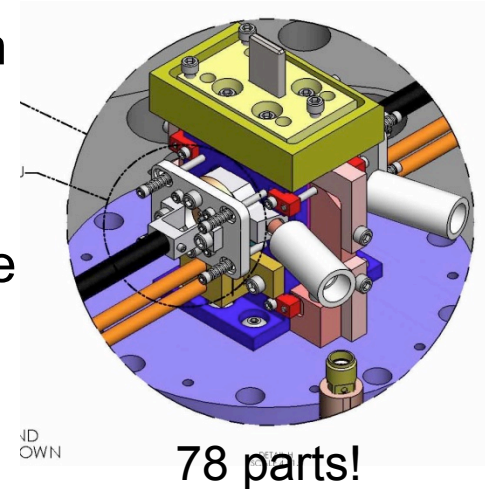

We've spent this year re-establishing cryogenic capabilities on Z

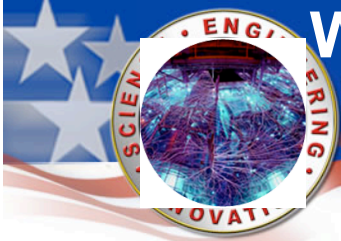

D.L. Hanson

Z cryogenic transfer lines

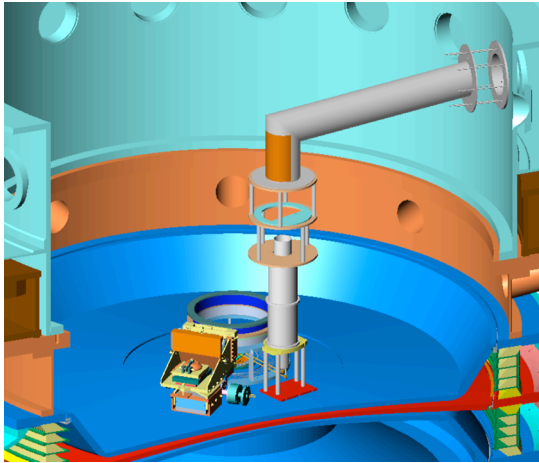

Z center section



Cryostat

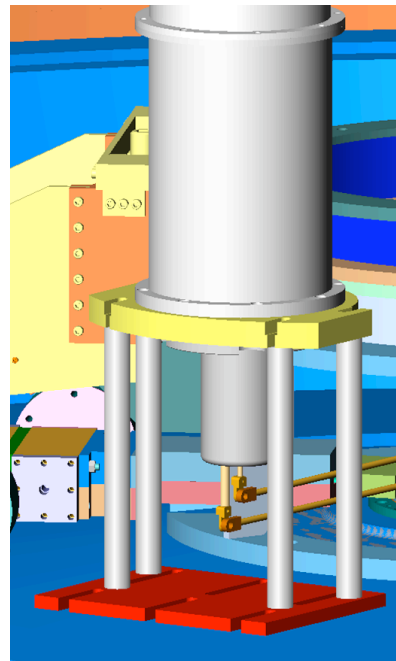

Cryogenic cells for EOS

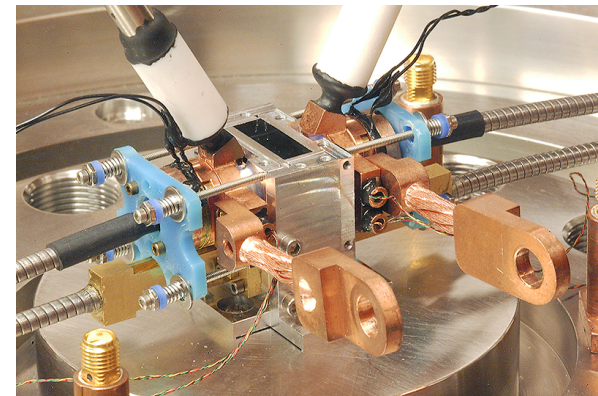

Cryogenic target for fast ignition

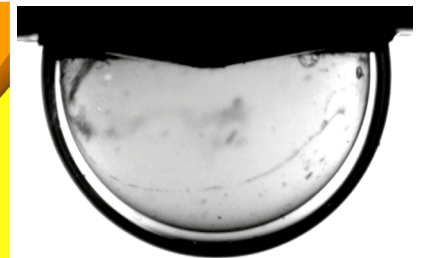
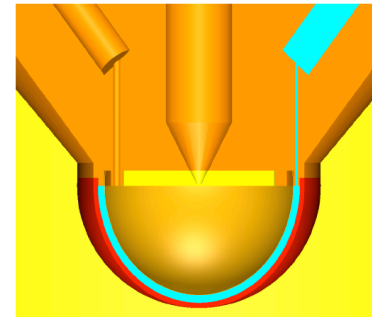

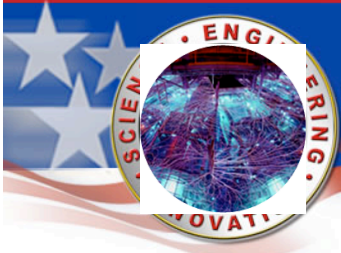

Other capabilities are under development

- On a 1 to 2 year timescale on Z
 - Z-Beamlet laser for target heating (≥ 2 kJ at 2ω)
 - Z-PW for single frame high energy radiography (25 keV point projection)
 - 10-15 Tesla axial magnetic fields at the loads
 - Triple-nozzle supersonic gas puffs or gas jets
- Other possibilities on a 2 to 3 year timescale on Z
 - Z-PW for single frame high energy radiography (25 keV crystal imaging)
 - Z-PW for target heating
 - Z-PW for ion beam production (proton radiography or ion beam target heating)

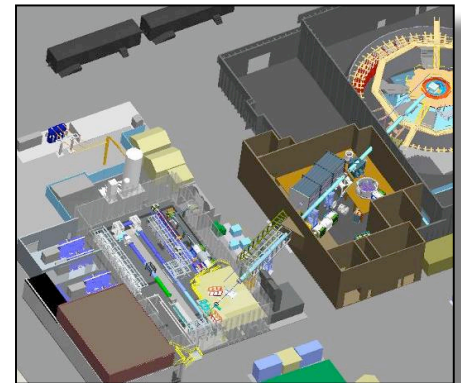



“Platforms” are combinations of mature sources and diagnostics and other capabilities

Sources	Diagnostics	Capabilities	Targets	Simulations
Radiation sources	X-ray power/energy	Gas fills	Fabrication of simple targets	“Facility outputs”
arrays	X-ray imaging	Cryogenics	Characterization	Circuit simulations
gas puffs	Radiography	Axial magnetic fields	Rad-magneto-hydrodynamics
Hohlraums	Spectroscopy	Laser heating	
Magnetic pressure sources	Neutronics	Target pre-heat	Your targets	Your simulations
ICE	VISAR	Current pulse-shaping	Your characterization	
Flyers	Electrical	Z-PW		
Neutron sources		
MagLIF				
Gas puffs				
Your source here	Your diagnostic here	Your capability here		



“Platforms” are combinations of mature sources and diagnostics and other capabilities

Experimental “ingredients”

Themes:
 ingredients, intersection
 inspiration, imagination, improvisation
 ingenuity, invention, innovation
 important, illustrious, influential

Sources	Diagnostics	Capabilities	Targets	Simulations
Radiation sources	X-ray power/energy	Gas fills	Fabrication	“Facility outputs”
arrays	X-ray imaging	Cryogenics	Characterization	Staff simulations
gas puffs	Radiography	Axial magnetic fields	Your simulations
Hohlraums	Spectroscopy	Laser heating		
Magnetic pressure sources	Neutronics	Target pre-heat	Your targets	
ICE	VISAR	Current pulse-shaping	Your characterization	
Flyers	Electrical	Z-PW		
Neutron sources		
MagLIF				
Gas puffs				
Your source here	Your diagnostics here	Your capability here		



Experiments must “fill” the center 5 ft³ of the facility

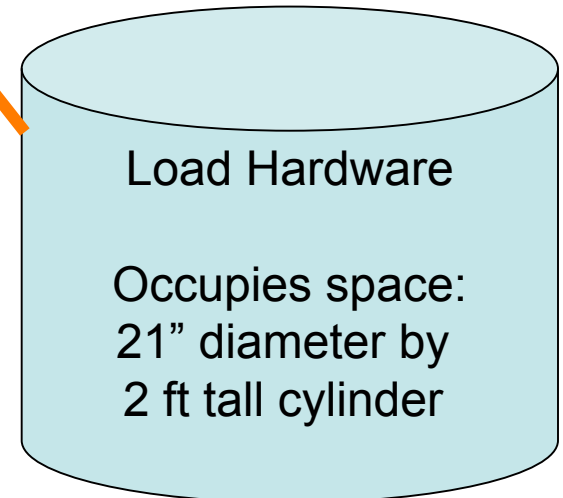
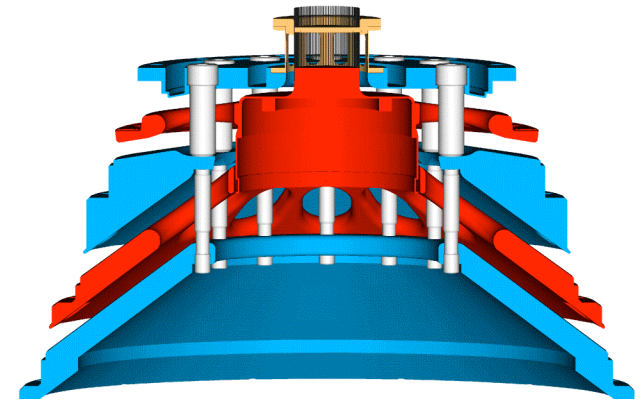
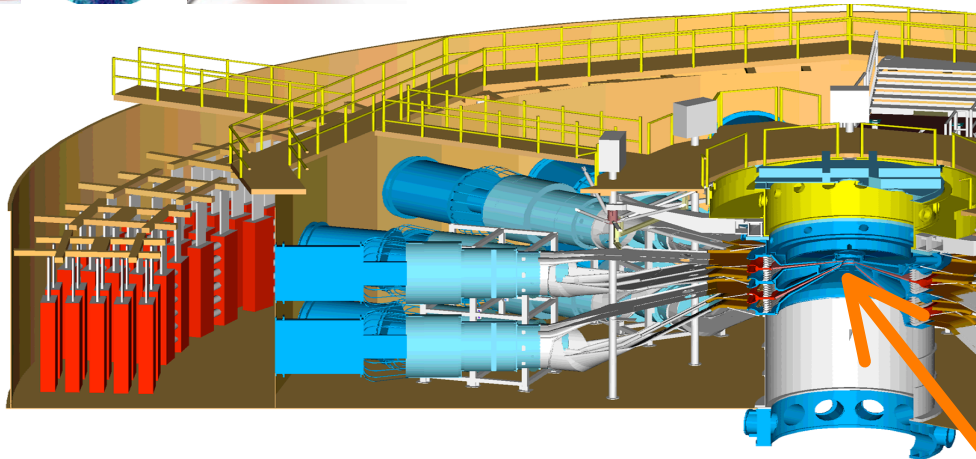

Entities involved in performance of experiment on Z

- Z Load Hardware Design
- Team Specialty Products
- MPCL
- General Atomics
- Target assembly and characterization laboratory
- Wire array laboratory
- Z facility operations
- ESH
- Z science operations (diagnostics)
- Z backlighter operations
- Physics departments

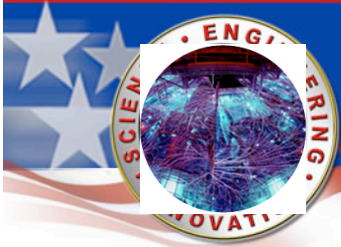

Phase A: experiment development and preparation process timelines

Phase A: Generate an idea for new research involving Z as one element

Discuss proposal for interest and feasibility of execution with facility director. Get a letter of interest.

Collaborate with Z personnel to improve the proposal, details of implementation

Prepare and submit a proposal to NNSA, NSF, OFES, DOE, AFOSR, etc.

Proposal is funded!



Phase B: experiment development and preparation process timelines

Phase B: Submit proposal for experiments on the Z facility to the Z external call process

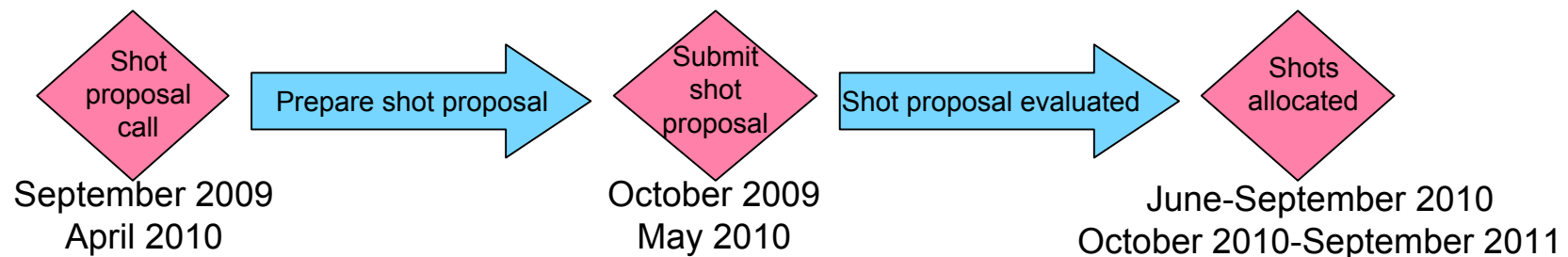

Proposals (that have external funding) are evaluated for facility use allocated to the basic science program

Experiments that have the highest technical merit, scientific interest, best planning, and feasibility of execution will have the best chance



Phase C: experiment development and preparation process timelines

Phase C: Collaborate with facility experts on design and execution of experiments, began design and fabrication of special targets, discuss diagnostic requirements

Realistically some of this would have been done before Phase B

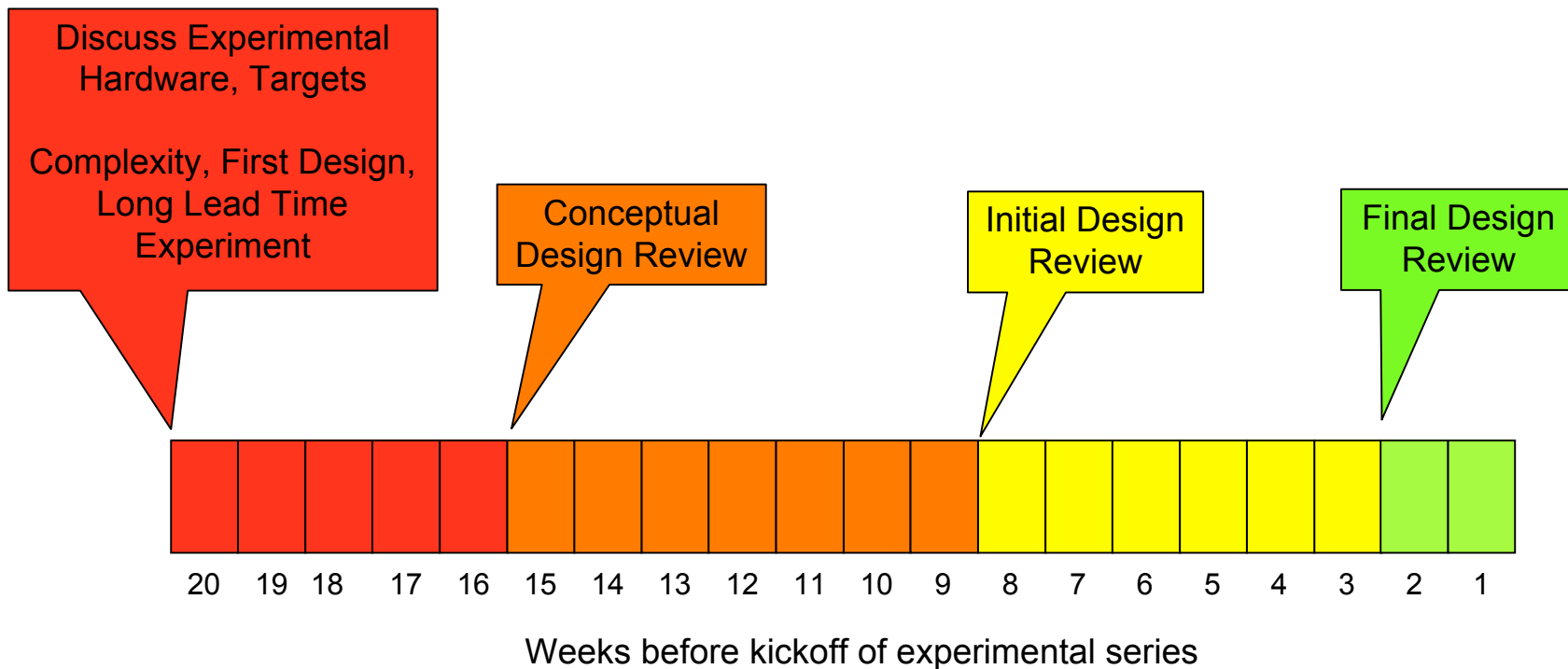

This is an example only – your pre-shot preparation could be longer



Phase D: experiment development and preparation process timelines

Phase D: submit design and other requirements to “kick off” production of hardware by the Z supply chain, pre-preparation by Z operations

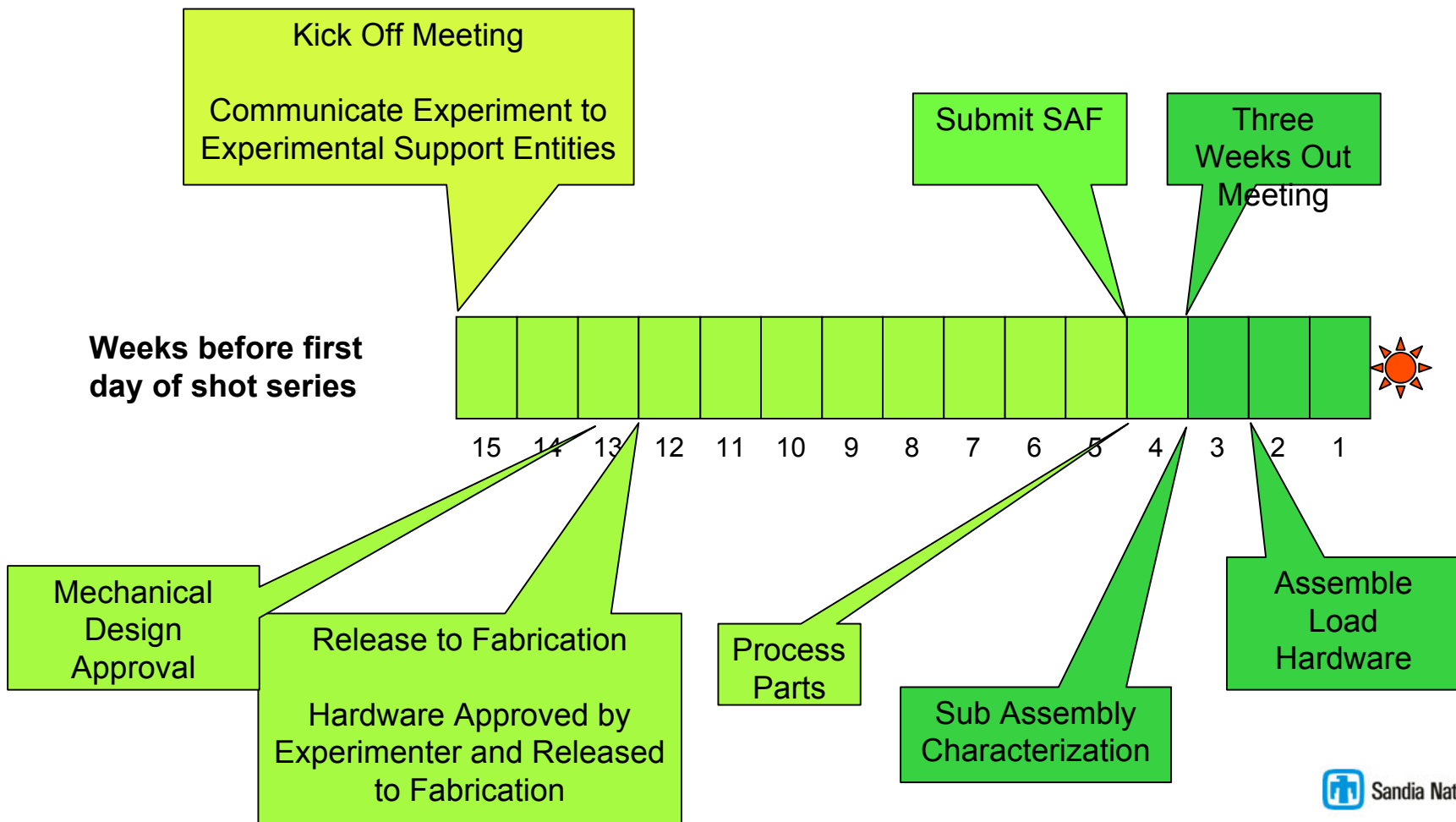



Some keys for successful experiments

- **Preparation, preparation, preparation**

- If possible, use mature sources and diagnostics, with little or only small modifications. This will shorten Phase C work.
- Read all the published work on the platform you propose to use
- Develop key capabilities in “ride-along” modes or on smaller facilities, if possible (1 MA, 6 MA)
- Perhaps as much as a year of planning and design is needed prior to setting requirements.
- Must freeze the design and all the requirements 15 weeks before the experiment
- Work with the diagnostics experts, facility scientists, and load hardware engineer to resolve all incompatibilities (lines of sight, interferences)
- Target fabrication and characterization can be the difference between success and failure. Target fabrication for complex targets could take 0.5 to 1 year.
- Experience suggests that a minimum of 9 to 12 experiments are required for a high profile publishable result. This is 3 weeks of experiments.
- If you need a new diagnostic, plan for at least an extra year. We have a “hostile” environment (debris, noise, background) that is challenging for instrumentation.
- Z experiments are too expensive to be “try it and see”. Need comprehensive designs, predictions, decision trees.



Some keys for successful experiments

- **Simulation, simulation, simulation**
 - Perform many different kinds of simulations of experiments using outputs from previous Z experiments
 - Simulate the performance of the Z pulsed power driver
 - Refine simulations continuously up until shot day
 - Predictions of diagnostic signatures, timing, target performance.
- **Communication, communication, communication**
 - Build a good collaborative relationship with key facility scientists/technicians. It takes more than 1 year of mentoring to be an experimental lead on the Z facility.
 - Of order 100 to 150 folks are involved in various stages of design, fabrication, assembly, installation, and execution of experiments on Z. You will need to be familiar with the process and the folks.
 - You (or your delegates) will need to be available and often present in Albuquerque